



# Parker Motion Controller

Intelligent Multi-Axis Motion Controller



ENGINEERING YOUR SUCCESS.



**WARNING — USER RESPONSIBILITY**

FAILURE OR IMPROPER SELECTION OR IMPROPER USE OF THE PRODUCTS DESCRIBED HEREIN OR RELATED ITEMS CAN CAUSE DEATH, PERSONAL INJURY AND PROPERTY DAMAGE.

- This document and other information from Parker-Hannifin Corporation, its subsidiaries and authorized distributors provide product or system options for further investigation by users having technical expertise.
- The user, through its own analysis and testing, is solely responsible for making the final selection of the system and components and assuring that all performance, endurance, maintenance, safety and warning requirements of the application are met. The user must analyze all aspects of the application, follow applicable industry standards, and follow the information concerning the product in the current product catalog and in any other materials provided from Parker or its subsidiaries or authorized distributors.
- To the extent that Parker or its subsidiaries or authorized distributors provide component or system options based upon data or specifications provided by the user, the user is responsible for determining that such data and specifications are suitable and sufficient for all applications and reasonably foreseeable uses of the components or systems.

<b>Overview.....</b>	<b>5</b>
<b>Product Overview.....</b>	<b>6</b>
<b>Technical Characteristics.....</b>	<b>9</b>
Parker Remote I/O System PACIO .....	10
Safety Controller .....	10
Dimensions .....	11
<b>Order Code.....</b>	<b>12</b>



# Parker Motion Controller - PAC

## Overview

### Description

The Parker motion Controller PAC is a PLC basing on ARM with integrated CODESYS. This programmable motion controller combines machine logic, real-time motion control and visualization into a standard based, performance driven, fan-less and easily mountable din rail solution.

The controller matches the PACIO modules, which can be attached directly to form a mechanically and electrically homogenous unit. In combination with these modules, it can take over complete machine control.

Equipped with a native, real-time EtherCAT bus, a modular interface slot, standard Ethernet and USB ports plus a built-in SD-card slot and the supported fieldbus options Profinet Slave, EtherCAT or EtherNet/IP the controller can be easily integrated and is suitable for a wide range of applications.

Programmed with CODESYS, efficient and powerful control systems can be designed based on IEC61131-3 and PLCopen motion standards. Offering the OPC UA server the controller is the perfect device for industry 4.0 communication.

Our PAC motion controller is available in two different versions:

PA120 and PAC340.

PAC120 is suitable for many motion applications.

For higher demands on performance and memory the PAC340 is available. With its four processor cores, it also supports the CODESYS multicore feature.



<b>General</b>	<b>PAC120</b>
<b>Function</b>	Mini-IPC with integrated CODESYS SPS and EtherCAT master function for I/O modules systems PACHC and PACIO
<b>Housing</b>	Aluminium strap, plastic
<b>Protection class</b>	IP20
<b>Mounting</b>	35 mm DIN rail
<b>Operation temperature</b>	0 °C...+55 °C

### Common Features

- Fan-less ARM processor technology
- Ethernet and EtherCAT
- Fieldbus options: EtherCAT, Profinet, EtherNet/IP, Modbus
- OPC UA server
- CODESYS V3.5
- CODESYS WebVisu
- CODESYS SoftMotion
- IEC61131-3 programming
- PLCopen motion control
- Web configuration tool
- SD card slot and USB interface
- Expandable with Parker PACIO modules
- DIN rail mounted



<b>General</b>	<b>PAC340</b>
<b>Function</b>	CODESYS PLC Motion Controller with a wide range of data interfaces
<b>Housing</b>	Aluminium strap
<b>Protection class</b>	IP20
<b>Mounting</b>	53 mm DIN rail
<b>Operation temperature</b>	Ambient operation temperature: (0 to +40) °C

## Product Overview

Designed to maximize efficiency while exceeding performance expectations, the Parker Automation Controller (PAC) is programmed with the well-established CODESYS, an Integrated Development Environment (IDE) and comprises the PAC I/O System. Together these elements provide a powerful, standards-based programmable package designed to tackle the most demanding applications. The PAC system consolidates machine logic, signal handling, advanced motion, and visualization.

### I/O Modules



The PAC I/O System comprises a variety of modules for digital, analog, temperature signals, high-speed counters, and communication interfaces.

### PAC120 overview:

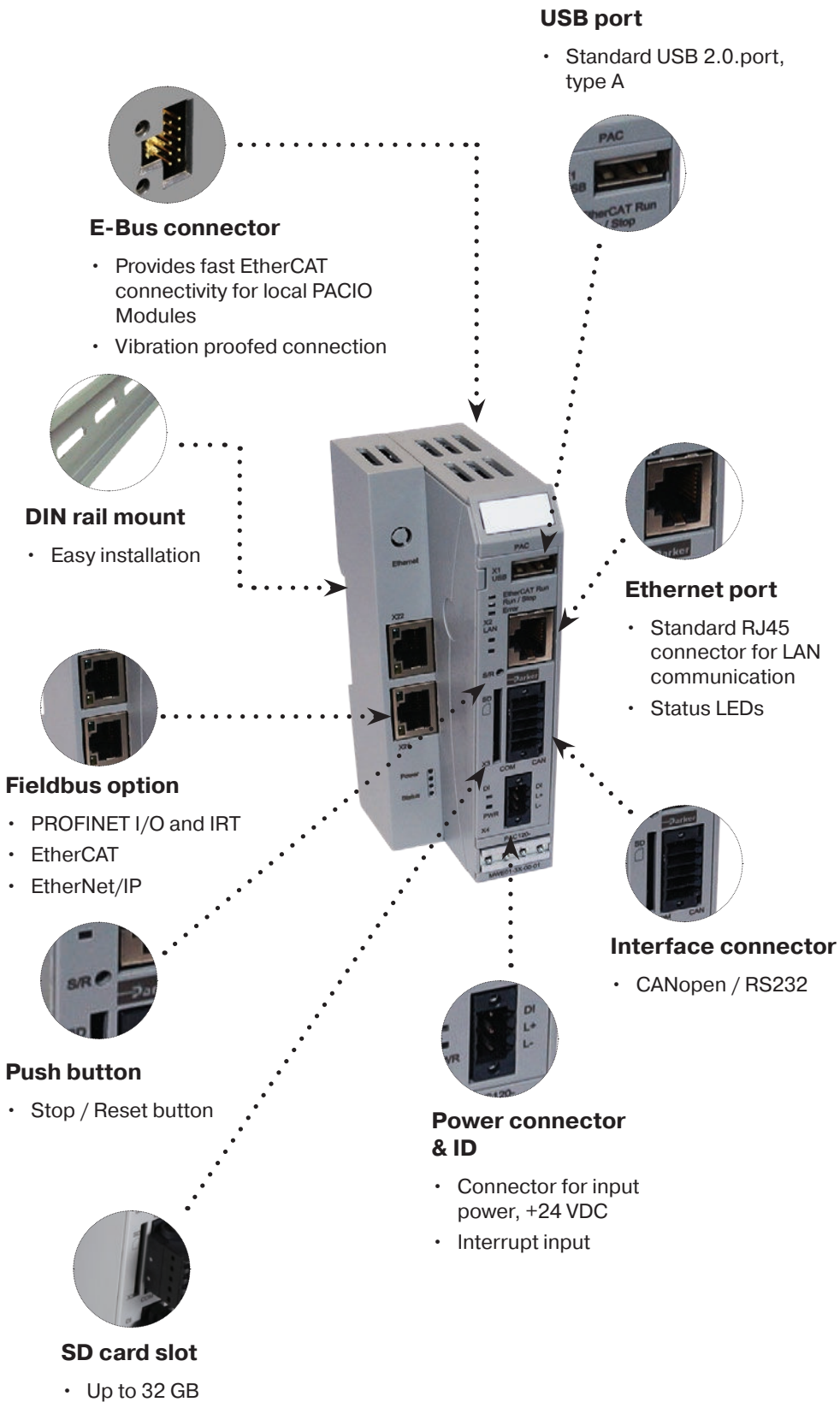

**I/O Modules overview:**

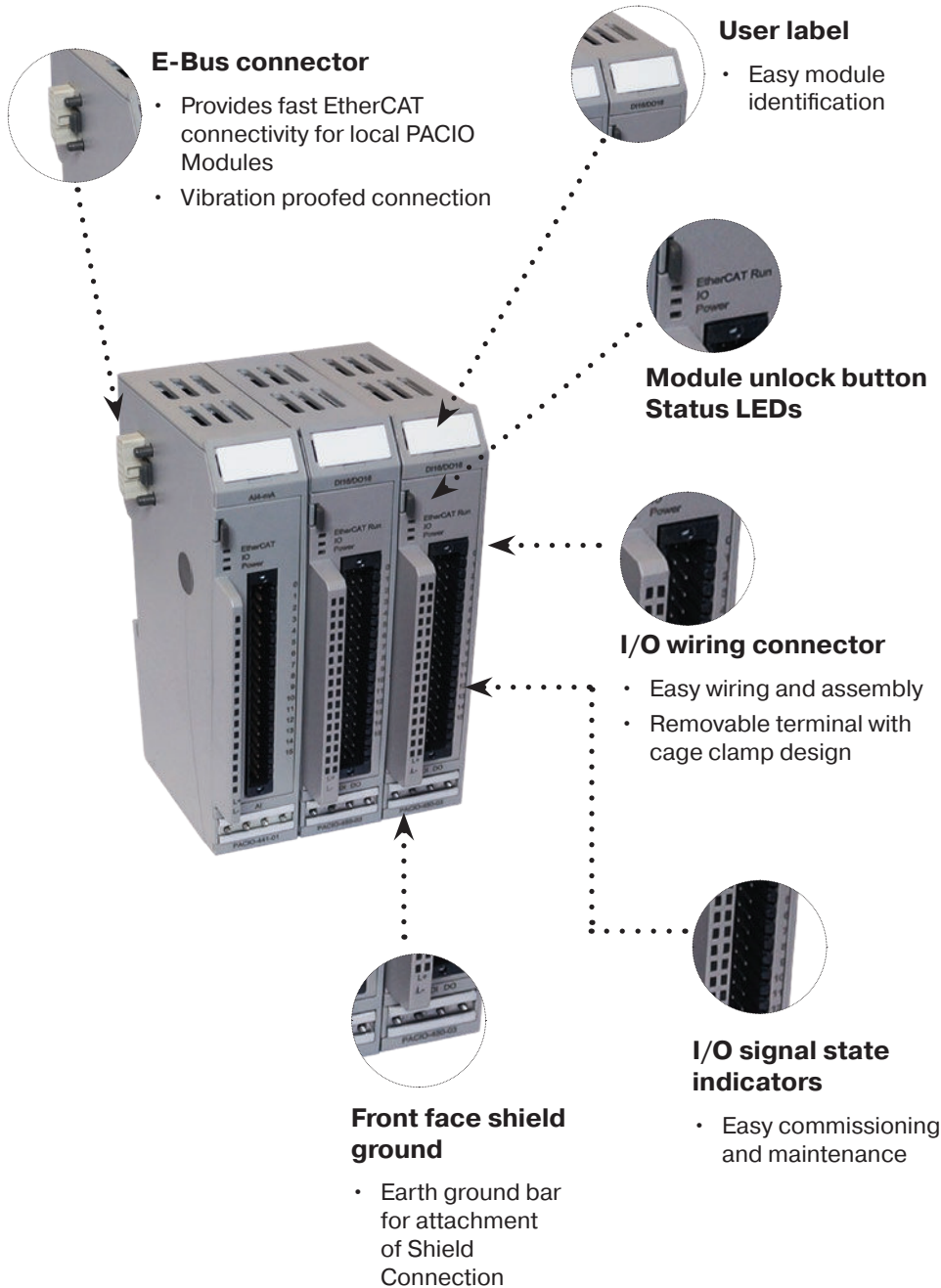

**Software**

CODESYS is the leading manufacturer-independent IEC 61131-3 automation software for engineering control systems. It's a software platform for industrial automation technology. The core of the platform is the IEC-61131-3 programming tool "CODESYS Development System". It offers practice-oriented, integrated solutions for the convenient configuration of automation applications. Everything is integrated in a single user interface

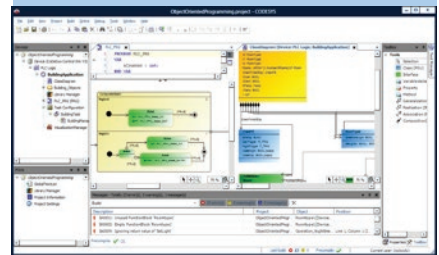

Engineers can work smarter, more efficiently and more effectively by choosing from the five IEC standard programming languages to optimize for an application, by using industry standard PLCopen Motion for motion control programming, deploying to the powerful simulation runtime for faster development and using online variable watch and trending for logic analysis.

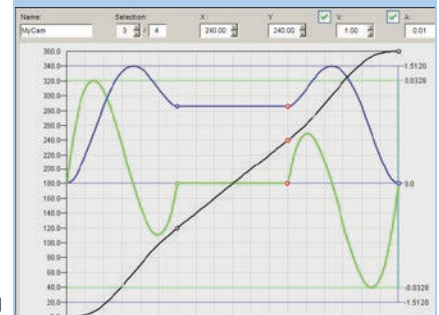

- IEC61131-3 programming system
- PLCopen motion control
- Simulation runtime
- Visualization
- CNC / robotics
- Industry 4.0 platform

**PAC340 overview:**

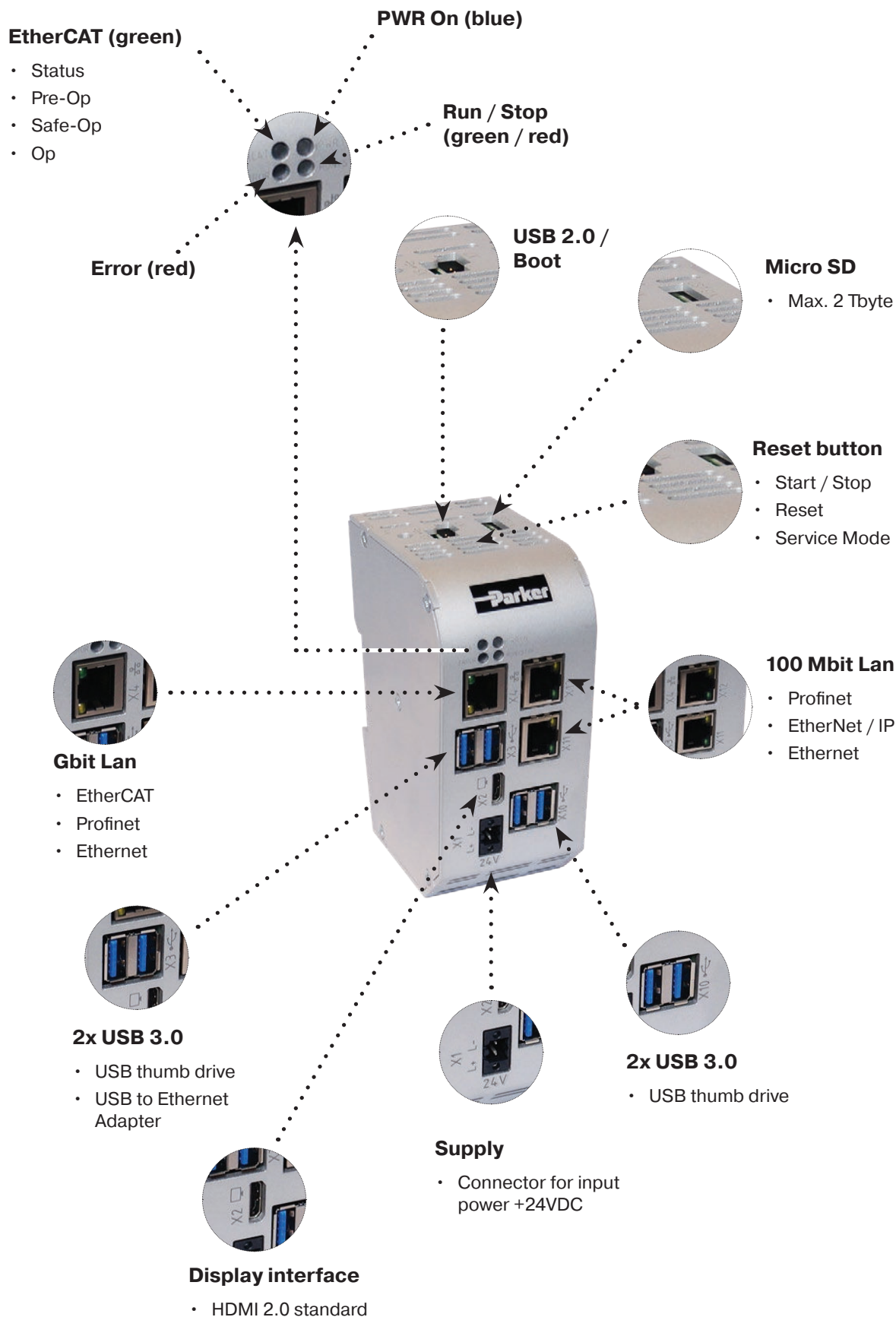



## Technical Characteristics

Electrical	PAC120	PAC340
<b>CPU</b>	i.MX6 SoloX Freescale 1 GHz	BCM2711, 1.5GHz Quad Core
<b>RAM / Flash</b>	256 MB / 256 MB	2 GB / 8GB
<b>Retain Memory</b>	128 MB	200 MB
<b>Operating system</b>	Linux RT	Linux RT
<b>Software</b>	CODESYS V3 runtime softmotion	CODESYS V3 runtime softmotion
<b>Network</b>	1 x Ethernet 10/100 MBit	1 x Ethernet 10/1000 Base, RJ45 1 x Ethernet 10/100 Base 2-Port Switch
<b>interfaces</b>	1 x digital input, 1ms 1 x USB 2.0 1 x SD (HC) card slot	1 x digital display Interface 3x USB 3.0 1 x $\mu$ SD (SDXC)
<b>Digital and analog interfaces</b>	Parker PACIO extension modules	Parker PACIO extension modules
<b>Field bus interfaces</b>	EtherCAT master via Extender Module CANopen, galvanic isolated ProfiNet IO and IRT (PAC120-*P), EtherCAT Slave (PAC120-*T), EtherNet/IP Adapter (PAC120-*E) OPC UA server	EtherCAT Master Profinet-Device-IEC Ethernet/IP-Scanner, Ethernet/IP-Adapter OPC UA server
<b>Clock</b>	Real-time clock with battery buffering	Real-time clock, 72h buffer
<b>Power supply</b>	24 V DC (19.2... 28.8)	24 V DC (19.2... 28.8)
<b>Potential separation</b>	Modules are potential separated against each other and bus	Modules are potential separated against each other and bus
<b>Industrial requirements</b>	Protection class III according to EN 601131-2	Protection class III according to EN 601131-2
<b>EMC</b>	2004/108/EC	2014/30/EU emitted interference: EN 61000-6-4, industrial zone
<b>Environmental conditions</b>	Relative humidity 5 % ... 95 % w/o dew	Relative humidity max. 85%, non-condensing
<b>CE conformity</b>	2004/108/EC	CE (EN 61131-2)
<b>UL certification</b>	Certified: E-File-No. E506274	Available April 2022

## Parker Remote I/O System PACIO

The PACIO System comprises a variety of modules for digital, analog and temperature signals as well as communication interfaces. The modules connect directly to the controller via the built-in EtherCAT bus for local architectures and are extended to remote locations via the extender and bus coupler modules, thus supporting both local and distributed I/O architectures. PACIO communicates natively on the EtherCAT bus, therefore it provides the full functionality and throughput of high-speed Ether-CAT to meet the most demanding real-time requirements. For further information see Parker catalogue file for the PACIOs.



Module Type	Part Number	PACIO Description
<b>Interfaces</b>	PACIO-400-00	PACIO EtherCAT Bus coupler, 3 A
	PACIO-400-02	PACIO Extender 2 Port (EtherCAT I/O extender)
<b>Accessories</b>	PACIO-411-00	Power Distribution Module (distributes 0 VDC or 24 VDC attached at pins L1 or L2)
	PACIO-412-01	PACIO Shield 2x8 mm
	PACIO-412-02	PACIO Shield 14 mm
<b>Analog</b>	PACIO-441-01	PACIO AI4-mA (4 single-ended analog input module), 12 Bit resolution
	PACIO-441-02	PACIO AI4/8-VDC (4 differential/8 single-ended analog input module), 13 Bit
	PACIO-441-51	PACIO AI4-mA (4 single-ended analog input module), 12 Bit CoE
	PACIO-441-52	PACIO AI4/8-VDC (4 differential/8 single-ended analog input module), 13 Bit CoE
	PACIO-442-02	PACIO AO4-VDC/mA (4 analog output module), 12 Bit resolution
	PACIO-442-52	PACIO AO4-VDC/mA (4 analog output module), 12 Bit resolution CoE
<b>Temperature</b>	PACIO-443-01	PACIO AI4-Pt/Ni100 (4 analog inputs, 70 to 300 ohm resistance), 16 Bit
	PACIO-443-03	PACIO AI4-Pt/Ni1000 (4 analog inputs, 70 to 3000 ohm resistance), 16 Bit
	PACIO-443-06	PACIO AI8-Thermocouple, 16 Bit
	PACIO-443-57	PACIO AI4-Pt/Ni/Thermo, 16 Bit CoE
	PACIO-443-58	PACIO AI8-Pt/Ni/Thermo, 16 Bit CoE
<b>Digital I/O Modules</b>	PACIO-450-02	PACIO DI16/DO8 (16 inputs/8 outputs), 1 A
	PACIO-450-03	PACIO DI16/DO16 (16 inputs/16 outputs), 1 ms delay, 0.5 A
	PACIO-450-05	PACIO DI8/DO8 (8 inputs/8 outputs), 1 ms delay, 0.5 A
	PACIO-450-13	PACIO DI16/DO16 (16 inputs/16 outputs), 1 ms delay, 0.5 A Low-side
	PACIO-451-02	PACIO DI32 (32 inputs), 1 ms delay
	PACIO-451-03	PACIO DI16 (16 inputs), 1 ms delay
	PACIO-452-01	PACIO DO16 (16 outputs), 0.5 A
	PACIO-452-02	PACIO DO8 (8 outputs) 1 A
<b>Counter</b>	PACIO-454-01	PACIO Counter/Enc (encoder counter module)

## Safety Controller

Safety PLC is a module intended to be integrated in EtherCAT® networks with Parker Motion Controller. Acting as the FSoE master, it is able to address any FSoE slave including safety I/Os, motion controllers and other FSoE equipment. The Safety PLC meets the requirements of IEC 61508 SIL3 and DIN EN ISO 13849 PLe. The main controller's CODESYS environment and the EtherCAT link are used for programming.



Part Number	Description
694.330.00	Safety PLC
694.430.00	Safety SDI4/SDO2 (4 safe inputs, 2 safe outputs)
694.430.10	Safety IO Module SDI8/SDO2
694.430.20	Safety IO Module SDI16/SDO4

## Dimensions

### PAC120 Dimensions

Dimensions [mm]

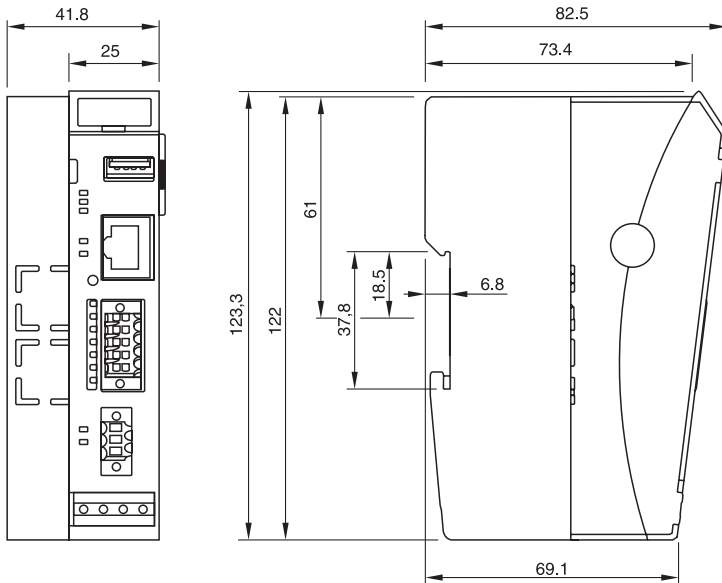

### PAC340 Dimensions

Dimensions [mm]

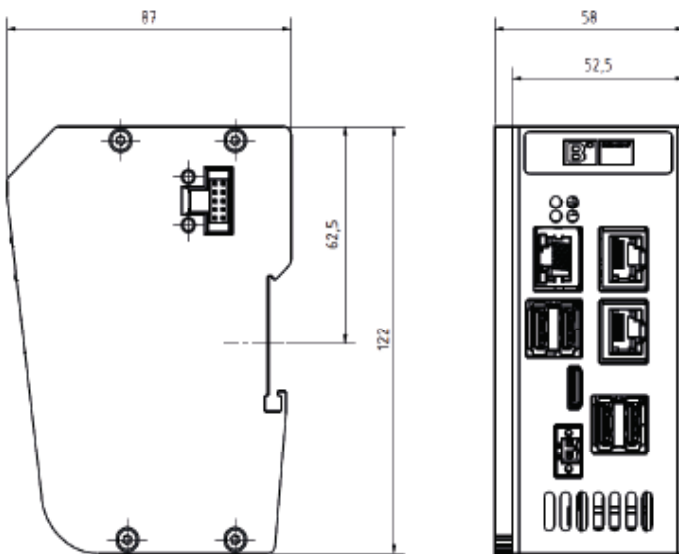

### I/O Dimensions

Dimensions [mm]

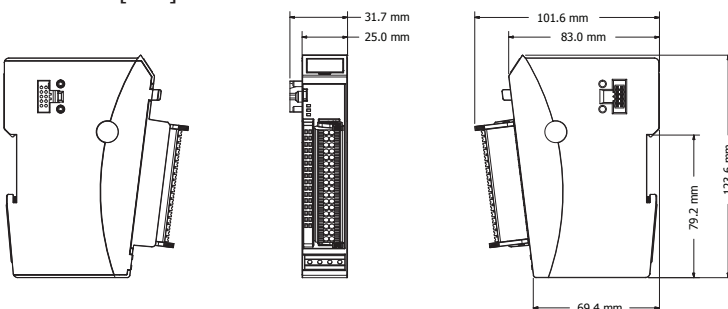

## Order Code

### Parker Motion Controller

	1	2		3	4	5	6	7		8	9		10		11
Order example	<b>PAC</b>	<b>120</b>	-	<b>M</b>	<b>W</b>	<b>E</b>	<b>0</b>	<b>1</b>	-	<b>3</b>	<b>X</b>	-	<b>00</b>	-	<b>01</b>

<b>1 Series</b>	<b>PAC</b>	Parker Motion controller
<b>2 Type</b>	<b>120</b>	
	<b>340</b>	
<b>3 Software</b>	<b>M</b>	IEC, PLCopen Motion
	<b>C</b>	IEC, PLCopen Motion, CNC (PAC340 only)
<b>4 Visualization</b>	<b>W</b>	Web Visualization
<b>5 Communication</b>	<b>E</b>	EtherNet/IP (PAC120 only)
	<b>P</b>	PROFINET IRT slave (PAC120 only)
	<b>B</b>	EtherNet/IP + PROFINET (PAC340 only)
<b>6 Retentive Memory</b>	<b>0</b>	128 kB (PAC120 only)
	<b>1</b>	200 kB (PAC340 only)
<b>7 Processor</b>	<b>1</b>	i.MX6 SoloX Freescale 1 GHz (PAC120)
	<b>1</b>	BCM2711, 1.5GHz Quad Core (PAC340)
<b>8 Certification</b>	<b>3</b>	UL / cUL / CE Certification
<b>9 Reserved</b>	<b>X</b>	Standard
<b>10 Extended Software</b>	<b>00</b>	Extended Software
<b>11 Extended communication</b>	<b>01</b>	Enhanced communication OPC UA



# Parker's Motion & Control Technologies

At Parker, we're guided by a relentless drive to help our customers become more productive and achieve higher levels of profitability by engineering the best systems for their requirements. It means looking at customer applications from many angles to find new ways to create value. Whatever the motion and control technology need, Parker has the experience, breadth of product and global reach to consistently deliver. No company knows more about motion and control technology than Parker. For further info call 00800 27 27 5374



## Aerospace Key Markets

- Aftermarket services
- Commercial transports
- Engines
- General & business aviation
- Helicopters
- Launch vehicles
- Military aircraft
- Missiles
- Power generation
- Regional transports
- Unmanned aerial vehicles

## Key Products

- Control systems & actuation products
- Engine systems & components
- Fluid conveyance systems & components
- Fluid metering, delivery & atomization devices
- Fuel systems & components
- Fuel tank inerting systems
- Hydraulic systems & components
- Thermal management
- Wheels & brakes



## Climate Control Key Markets

- Agriculture
- Air conditioning
- Construction Machinery
- Food & beverage
- Industrial machinery
- Life sciences
- Oil & gas
- Precision cooling
- Process
- Refrigeration
- Transportation

## Key Products

- Accumulators
- Advanced actuators
- CO<sub>2</sub> controls
- Electronic controllers
- Filter driers
- Hand shut-off valves
- Heat exchangers
- Hose & fittings
- Pressure regulating valves
- Refrigerant distributors
- Safety relief valves
- Smart pumps
- Solenoid valves
- Thermostatic expansion valves



## Electromechanical Key Markets

- Aerospace
- Factory automation
- Life science & medical
- Machine tools
- Packaging machinery
- Paper machinery
- Plastics machinery & converting
- Primary metals
- Semiconductor & electronics
- Textile
- Wire & cable

## Key Products

- AC/DC drives & systems
- Electric actuators, gantry robots & slides
- Electrohydraulic actuation systems
- Electromechanical actuation systems
- Human machine interface
- Linear motors
- Stepper motors, servo motors, drives & controls
- Structural extrusions



## Filtration Key Markets

- Aerospace
- Food & beverage
- Industrial plant & equipment
- Life sciences
- Marine
- Mobile equipment
- Oil & gas
- Power generation & renewable energy
- Process
- Transportation
- Water Purification

## Key Products

- Analytical gas generators
- Compressed air filters & dryers
- Engine air, coolant, fuel & oil filtration systems
- Fluid condition monitoring systems
- Hydraulic & lubrication filters
- Hydrogen, nitrogen & zero air generators
- Instrumentation filters
- Membrane & fiber filters
- Microfiltration
- Sterile air filtration
- Water desalination & purification filters & systems



## Fluid & Gas Handling Key Markets

- Aerial lift
- Agriculture
- Bulk chemical handling
- Construction machinery
- Food & beverage
- Fuel & gas delivery
- Industrial machinery
- Life sciences
- Marine
- Mining
- Mobile
- Oil & gas
- Renewable energy
- Transportation

## Key Products

- Check valves
- Connectors for low pressure fluid conveyance
- Deep sea umbilicals
- Diagnostic equipment
- Hose couplings
- Industrial hose
- Mooring systems & power cables
- PTFE hose & tubing
- Quick couplings
- Rubber & thermoplastic hose
- Tube fittings & adapters
- Tubing & plastic fittings



## Hydraulics Key Markets

- Aerial lift
- Agriculture
- Alternative energy
- Construction machinery
- Forestry
- Industrial machinery
- Machine tools
- Marine
- Material handling
- Mining
- Oil & gas
- Power generation
- Refuse vehicles
- Renewable energy
- Truck hydraulics
- Turf equipment

## Key Products

- Accumulators
- Cartridge valves
- Electrohydraulic actuators
- Human machine interfaces
- Hybrid drives
- Hydraulic cylinders
- Hydraulic motors & pumps
- Hydraulic systems
- Hydraulic valves & controls
- Hydrostatic steering
- Integrated hydraulic circuits
- Power take-offs
- Power units
- Rotary actuators
- Sensors



## Pneumatics Key Markets

- Aerospace
- Conveyor & material handling
- Factory automation
- Life science & medical
- Machine tools
- Packaging machinery
- Transportation & automotive

## Key Products

- Air preparation
- Brass fittings & valves
- Manifolds
- Pneumatic accessories
- Pneumatic actuators & grippers
- Pneumatic valves & controls
- Quick disconnects
- Rotary actuators
- Rubber & thermoplastic hose & couplings
- Structural extrusions
- Thermoplastic tubing & fittings
- Vacuum generators, cups & sensors



## Process Control Key Markets

- Alternative fuels
- Biopharmaceuticals
- Chemical & refining
- Food & beverage
- Marine & shipbuilding
- Medical & dental
- Microelectronics
- Nuclear Power
- Offshore oil exploration
- Oil & gas
- Pharmaceuticals
- Power generation
- Pulp & paper
- Steel
- Water/wastewater

## Key Products

- Analytical Instruments
- Analytical sample conditioning products & systems
- Chemical injection fittings & valves
- Fluoropolymer chemical delivery fittings, valves & pumps
- High purity gas delivery fittings, valves, regulators & digital flow controllers
- Industrial mass flow meters/ controllers
- Permanent no-weld tube fittings
- Precision industrial regulators & flow controllers
- Process control double block & bleeds
- Process control fittings, valves, regulators & manifold valves



## Sealing & Shielding Key Markets

- Aerospace
- Chemical processing
- Consumer
- Fluid power
- General industrial
- Information technology
- Life sciences
- Microelectronics
- Military
- Oil & gas
- Power generation
- Renewable energy
- Telecommunications
- Transportation

## Key Products

- Dynamic seals
- Elastomeric o-rings
- Electro-medical instrument design & assembly
- EMI shielding
- Extruded & precision-cut, fabricated elastomeric seals
- High temperature metal seals
- Homogeneous & inserted elastomeric shapes
- Medical device fabrication & assembly
- Metal & plastic retained composite seals
- Shielded optical windows
- Silicone tubing & extrusions
- Thermal management
- Vibration dampening

# Parker Worldwide

## Europe, Middle East, Africa

**AE – United Arab Emirates,**  
Dubai  
Tel: +971 4 8127100

**AT – Austria,** St. Florian  
Tel: +43 (0)7224 66201

**BE/NL/LU – Benelux,**  
Hendrik Ido Ambacht  
Tel: +31 (0)541 585 000

**BY – Belarus,** Minsk  
Tel: +48 (0)22 573 24 00

**CH – Switzerland,** Etoy  
Tel: +41 (0)21 821 87 00

**CZ – Czech Republic,**  
Prague  
Tel: +420 284 083 111

**DE – Germany,** Kaarst  
Tel: +49 (0)2131 4016 0

**DK – Denmark,** Ballerup  
Tel: +45 43 56 04 00

**ES – Spain,** Madrid  
Tel: +34 902 330 001

**FI – Finland,** Vantaa  
Tel: +358 (0)20 753 2500

**FR – France,** Contamine s/Arve  
Tel: +33 (0)4 50 25 80 25

**HU – Hungary,** Budaörs  
Tel: +36 23 885 470

**IE – Ireland,** Dublin  
Tel: +353 (0)1 466 6370

**IL – Israel**  
Tel: +39 02 45 19 21

**IT – Italy,** Corsico (MI)  
Tel: +39 02 45 19 21

**NO – Norway,** Asker  
Tel: +47 66 75 34 00

**PL – Poland,** Warsaw  
Tel: +48 (0)22 573 24 00

**PT – Portugal**  
Tel: +351 22 999 7360

**RO – Romania,** Bucharest

Tel: +40 21 252 1382

**RU – Russia,** Moscow  
Tel: +7 495 645-2156

**SE – Sweden,** Borås  
Tel: +46 (0)8 59 79 50 00

**SL – Slovenia,** Novo Mesto  
Tel: +386 7 337 6650

**TR – Turkey,** Istanbul  
Tel: +90 216 4997081

**UK – United Kingdom,** Warwick  
Tel: +44 (0)1926 317 878

**ZA – South Africa,** Kempton  
Park  
Tel: +27 (0)11 961 0700

Tel: +662 186 7000

**TW – Taiwan,** Taipei  
Tel: +886 2 2298 8987

## South America

**AR – Argentina,** Buenos Aires  
Tel: +54 3327 44 4129

**BR – Brazil,** Sao Jose dos  
Campos  
Tel: +55 080 0727 5374

**CL – Chile,** Santiago  
Tel: +56 22 303 9640

**MX – Mexico,** Toluca  
Tel: +52 72 2275 4200

## North America

**CA – Canada,** Milton, Ontario  
Tel: +1 905 693 3000

**US – USA,** Cleveland  
Tel: +1 216 896 3000

## Asia Pacific

**AU – Australia,** Castle Hill  
Tel: +61 (0)2-9634 7777

**CN – China,** Shanghai  
Tel: +86 21 2899 5000

**HK – Hong Kong**  
Tel: +852 2428 8008

**IN – India,** Mumbai  
Tel: +91 22 6513 7081-85

**JP – Japan,** Tokyo  
Tel: +81 (0)3 6408 3901

**KR – South Korea,** Seoul  
Tel: +82 2 559 0400

**MY – Malaysia,** Shah Alam  
Tel: +60 3 7849 0800

**NZ – New Zealand,** Mt  
Wellington  
Tel: +64 9 574 1744

**SG – Singapore**  
Tel: +65 6887 6300

**TH – Thailand,** Bangkok

### EMEA Product Information Centre

**Free phone: 00 800 27 27 5374**

(from AT, BE, CH, CZ, DE, DK, EE, ES, FI, FR, IE, IL,  
IS, IT, LU, MT, NL, NO, PL, PT, RU, SE, SK, UK, ZA)

### US Product Information Centre

**Toll-free number: 1-800-27 27 537**

[www.parker.com](http://www.parker.com)

